



# AMARILLO® GEAR COMPANY LLC

Postal Address: Box 1789, Amarillo, Texas 79105

Plant Location: 2401 Sundown Lane, Amarillo, Texas 79118

T: 806-622-1273

FAX: 806-622-3258

www.amarillogear.com e-mail: info@amarillogear.com



## INSTALLATION AND ALIGNMENT INSTRUCTIONS FOR AMARILLO® COMPOSITE DRIVE SHAFTS

**SAFETY:** Rotating equipment is potentially dangerous. All couplings must have proper guarding according to OSHA and other applicable safety codes.

Make sure all bolts are torqued to the correct value listed in the installation instructions. **ONLY use hardware supplied by or specified by Amarillo Gear Company.**

Drive shafts should be inspected periodically, after any unexpected shock load, or after operating with alignment outside the tolerances provided in these instructions.

### TOOLS REQUIRED:

- Ratchet with 13 mm (size 52), 19 mm (Size 60 and 73 flex disc) or 22 mm (Size 67 and 83 flex disc) socket
- Combination wrench with 13 mm (size 52), 19 mm (Size 60 and 73 flex disc) or 22 mm (Size 67 and 83 flex discs) opening
- Torque wrench (max reading of 500 in-lb)
- Dial indicator with chain clamp
- Dial caliper
- Hex key (5 mm for size 60 and 67 flex discs or 6 mm for size 73 and 83 flex discs)
- Anti-seize compound (Included with new drive shafts and hardware kits)
- Tape measure

**INSTALLATION:** Refer to the product drawing included with each drive shaft. If another print is required, contact Amarillo Gear Company at 806-622-1273. Be ready to provide the part number and serial number from the drive shaft label. Align the motor and gear drive to each other prior to installing the drive shaft.

When re-boring stainless steel hubs, concentricity between the bolt holes and the hub must be maintained. This requires a fixture that attaches to the counter bored bolt circle and is best performed by Amarillo Gear Company. Use of re-bored hubs that do not meet Amarillo Gear Company specifications will void the warranty.

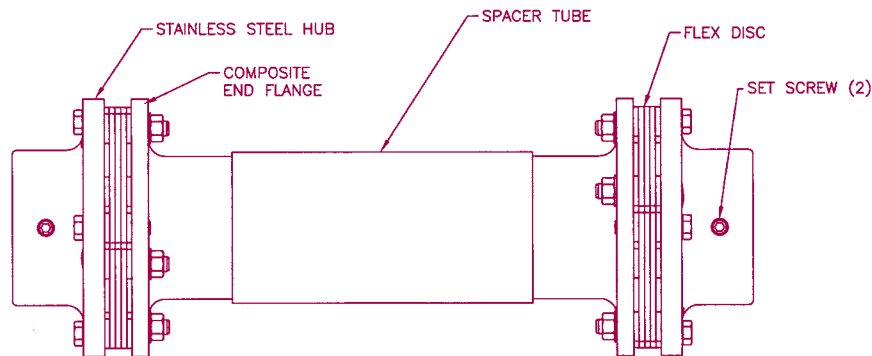

1. Using a tape measure, verify that the distance between shaft ends (DBSE) is the same as shown on the product drawing.
2. Drive shafts are shipped assembled from the factory. Remove the bolts that attach the flex disc to the composite end flange. **(It is not necessary to separate the flex disc from the stainless steel hub.)** Match marking is not necessary to maintain balance. **DO NOT** mark the components using mechanical means such as a chisel or punch.
3. Check the electric motor shaft, gear drive shaft, and both stainless steel hubs for burrs. Verify proper fit between the shaft and the stainless steel hub. The hubs are designed to have a clearance fit to the shafts according to CTI and AGMA standards. Hubs should slip freely on shafts without excessive play.
4. Apply a thin coat of anti-seize compound on the shaft of the electric motor and gear drive input shaft.

5. Mount the stainless steel hubs (with flex discs still attached) on the shafts. Position one hub flush with the shaft end and the other hub leaving at least 1" of shaft exposed.

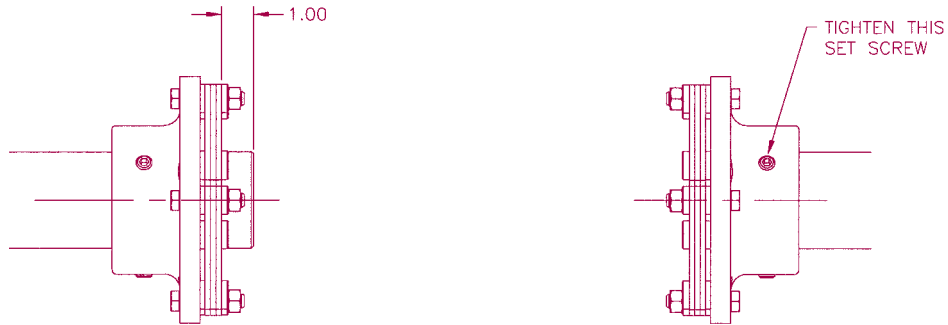

6. Lock the set screws on the hub that is flush with the shaft end.

7. Insert the spacer tube between the hubs as shown below. Align the clearance holes in the spacer tube with the bolts attaching the flex disc to the stainless steel hub.

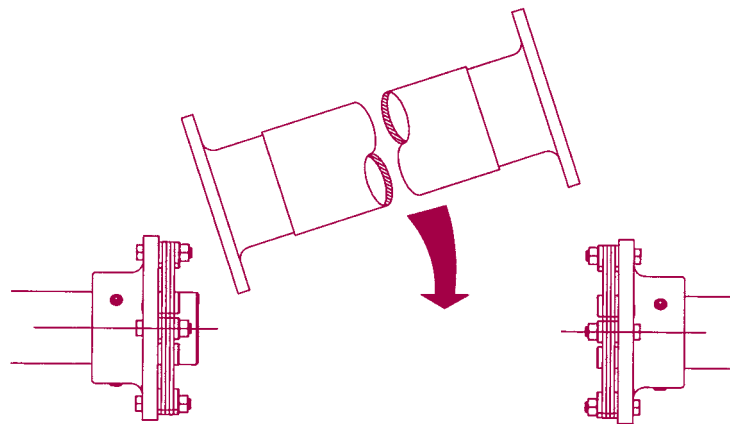

8. Slide the free hub into the spacer tube. Make sure that the bushings in the flex disc register into the counter bores on the composite end flange. Tighten at least one set screw in this hub to hold it in position. Note that this hub may have to be moved again during the alignment process.

9. Apply anti-seize compound (included) to the threads and insert the bolts through the clearance holes in the stainless steel hubs and through the flex disc and composite end flange. Install washers and nuts as shown below.

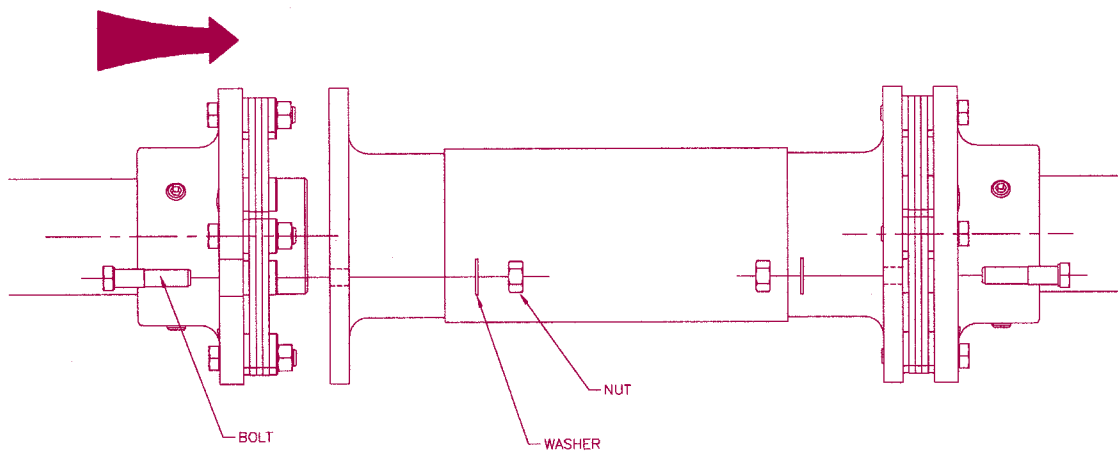

5. Mount the stainless steel hubs (with flex discs still attached) on the shafts. Position one hub flush with the shaft end and the other hub leaving at least 1" of shaft exposed.



6. Lock the set screws on the hub that is flush with the shaft end.
7. Insert the spacer tube between the hubs as shown below. Align the clearance holes in the spacer tube with the bolts attaching the flex disc to the stainless steel hub.

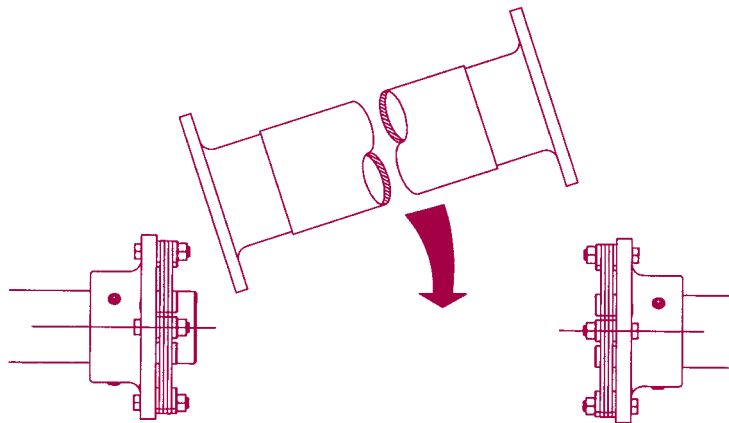

8. Slide the free hub into the spacer tube. Make sure that the bushings in the flex disc register into the counter bores on the composite end flange. Tighten at least one set screw in this hub to hold it in position. Note that this hub may have to be moved again during the alignment process.
9. Apply anti-seize compound (included) to the threads and insert the bolts through the clearance holes in the stainless steel hubs and through the flex disc and composite end flange. Install washers and nuts as shown below.

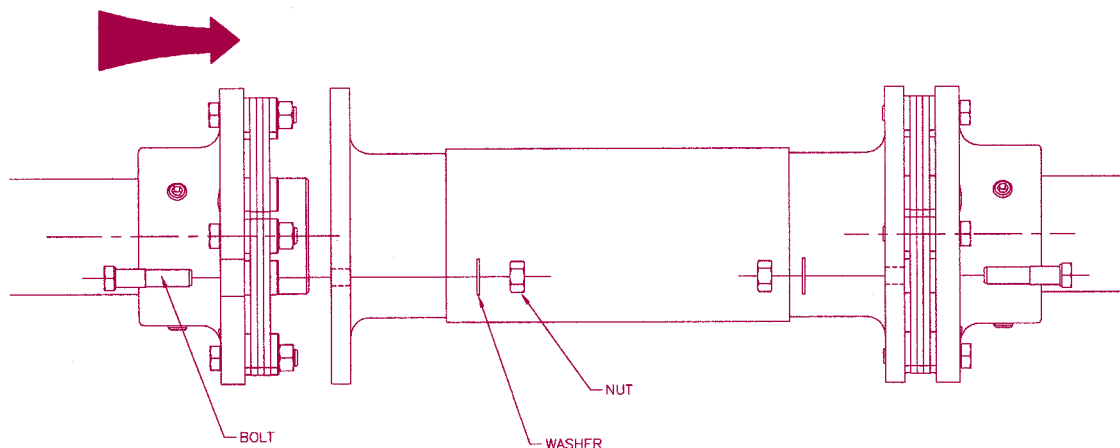

## CHECK HUB SEPARATION:

4. Using a dial caliper, check the hub separation by measuring the gap between the face of the stainless steel hub and the face of the composite end flange. Without rotating the drive shaft, take four readings at 90° intervals. Average the four readings and compare the result to the nominal reading shown below. If the average reading does not fall within the tolerance given, the hubs must be re-positioned.

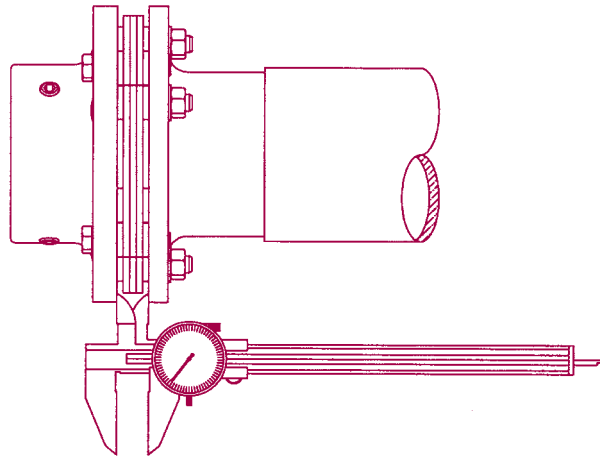

Model (Flex Disc Color)	Nominal Gap <sup>*</sup> (inch)	Gap Tolerance (inch)	Nominal Gap <sup>*</sup> (mm)	Gap Tolerance (mm)
52 (Red)	0.785	±0.030	19.94	±0.76
60 (Green)	0.782	±0.035	19.86	±0.89
67 (Orange)	0.874	±0.040	22.20	±1.02
73 (Blue)	1.000	±0.045	25.40	±1.14
83 (Yellow)	1.156	±0.055	29.36	±1.40

\*Verify these values with the dimension shown on the print supplied with the drive shaft. The print will contain the most current information.

- Torque all set screws to 50 in-lb (5.5 N-m).
- Repeat all of the alignment checks on the opposite end of the shaft.

### NOTICE FOR BORING HUBS:

All hub bores are accurately machined concentric to the counter bored hole pattern. Chucking on any of the outside diameters of the hub will not produce the required concentricity. Special tooling that accurately attaches to the hub counter bores is required.

## RECORD OF ALIGNMENT READINGS

Cell Number: \_\_\_\_\_

Angular Alignment			Hub Separation		
	Motor End	Gear Drive End		Motor End	Gear Drive End
0°			0°		
90°			90°		
180°			180°		
270°			270°		
Range			Average		